

# FMI625CN

Usable volume

25 l



Product Family

Microwave

Category

Built-in

Installation

Fully Built-in

Power supply

Electric

Cooking Method

Combi Microwave

Control

Electronic



## Controls



Display / Clock

1 a LED

Opening

Electrical button

Type of control setting

Touch control

## Options



Timer

Electronic

Controls Lock / Child Safety

Yes

Time-setting options

End cooking

Quick start option

Yes

End of cooking acoustic alarm

Yes

## Technical Features



Cavity material

Stainless steel

Circulaire heating element - Power

2500 W

No. of shelves/ levels

2

Door opening

Side-opening

Shelves type

Rack

Total no. of door glasses

1

No. of lights

1

Safety Thermostat

Yes

Light type

Led

Cooling system

Tangential

Turntable

Yes

Microwave screen protection

Yes

Turntable dimensions

31.5 cm

Microwave stops when door is opened

Yes

Light when door is opened

Yes

Grill type

Heating element

Grill - power	1100 W	Usable cavity space dimensions (HxWxD)	206x368x328 mm
		Microwave effective power	900 W

## Accessories Included







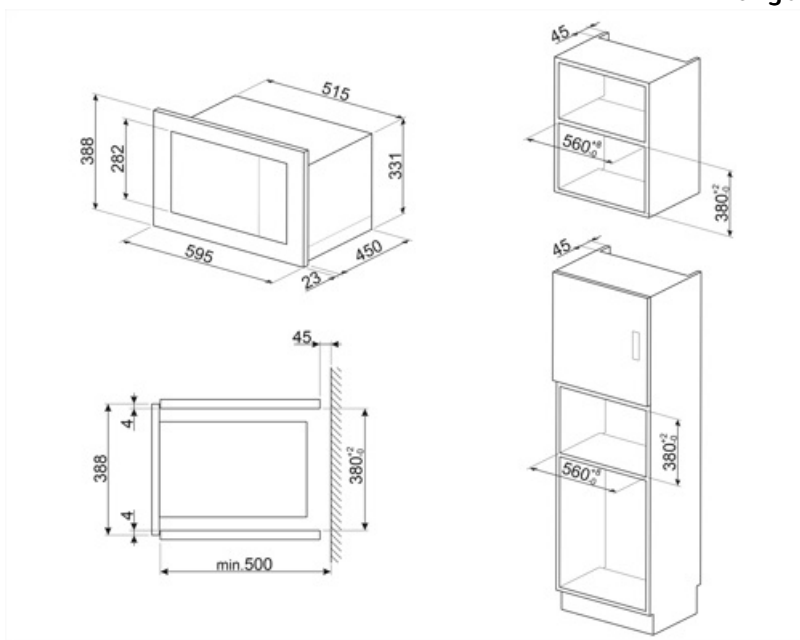





Grid	1	Frame	Yes
------	---	-------	-----

## Electrical Connection

Plug	Not present	Voltage (V)	230 V
Nominal power	2500 W	Frequency (Hz)	50 Hz
Current	11 A	Power supply cable length	150 cm



## Symbols glossary

-  Child lock: some models are fitted with a device to lock the programme/cycle so it cannot be accidentally changed.
-  Microwave energy shortens cooking times dramatically and produces energy savings.
-  Circulaire + grill: Circulaire with upper element or grill: Similar to fan with upper element with the added cooking speed of circulaire, ideal for dishes with a crispy topping. When used with the grill the food will brown more quickly.
-  Microwave: Penetrating straight into the food, microwaves cook very quickly and with considerable energy savings. Suitable for cooking without fat, they are also able to thaw and heat food without altering its original appearance and aroma. The microwave function can also be combined with conventional functions with all the resulting advantages. Ideal for all types of food.
-  Microwave + grill element: The use of the grill results in a perfect browning of the surface of the food. The action of microwaves allows instead of cooking in a short time the internal part of the food.
-  The oven cavity has 2 different cooking levels.
-  The capacity indicates the amount of usable space in the oven cavity in litres.
-  Combination microwave: This oven allows to combine two different ways of cooking (Traditional with microwaves). Combined ovens increase cooking opportunities, while providing maximum flexibility of household appliances.
-  Defrost by time: Manual defrost function. At the end of the set duration, the function stops.
-  Grill: Very intense heat coming only from above from a double heating element. The fan is not active. Provides excellent grilling and gratinating results. Used at the end of cooking, it gives a uniform browning to dishes.
-  Cooking with the simultaneous use of the heating element in combination with fan and microwave supply.
-  Side lights: Two opposing side lights increase visibility inside the oven.
-  Touch controls: Easy to use touch controls allow the appliance to be programmed at the touch of a button.